



PicoBlaze™

Software Implementation of Pulse Width Modulation (PWM).

A reference design using the
Spartan-3E Starter Kit

Ken Chapman
Xilinx Ltd
24th May 2006

Rev.1



Limitations

Limited Warranty and Disclaimer. These designs are provided to you “as is”. Xilinx and its licensors make and you receive no warranties or conditions, express, implied, statutory or otherwise, and Xilinx specifically disclaims any implied warranties of merchantability, non-infringement, or fitness for a particular purpose. Xilinx does not warrant that the functions contained in these designs will meet your requirements, or that the operation of these designs will be uninterrupted or error free, or that defects in the Designs will be corrected. Furthermore, Xilinx does not warrant or make any representations regarding use or the results of the use of the designs in terms of correctness, accuracy, reliability, or otherwise.

Limitation of Liability. In no event will Xilinx or its licensors be liable for any loss of data, lost profits, cost or procurement of substitute goods or services, or for any special, incidental, consequential, or indirect damages arising from the use or operation of the designs or accompanying documentation, however caused and on any theory of liability. This limitation will apply even if Xilinx has been advised of the possibility of such damage. This limitation shall apply notwithstanding the failure of the essential purpose of any limited remedies herein.

This design module is **not** supported by general Xilinx Technical support as an official Xilinx Product. Please refer any issues initially to the provider of the module.

Any problems or items felt of value in the continued improvement of KCPSM3 or this reference design would be gratefully received by the author.

Ken Chapman
Senior Staff Engineer – Spartan Applications Specialist
email: chapman@xilinx.com

The author would also be pleased to hear from anyone using KCPSM3 or the UART macros with information about your application and how these macros have been useful.



Design Overview

This design allows you to experiment with Pulse Width Modulation (PWM) implemented by a PicoBlaze processor. As supplied, the design will allow you to control 12 PWM channels; 8 channels control the intensity of the 8 LEDs on the board and the remaining 4 channels are provided on connector 'J4' which you can observe should you have access to an oscilloscope. You may also like to experiment with simple resistor-capacitor (RC) smoothing circuits connected to the header pins to create additional digital to analogue (D/A) converters or experiment with controlling motors via drive transistors.

The PWM implemented has a pulse repetition frequency (PRF) of 1KHz and an 8-bit resolution (256 steps). The duty cycle for Each LED or 'J4' output can be set independently using simple commands entered at a simple terminal program on your PC (HyperTerminal is ideal).

The PicoBlaze processor and UART macros occupy less than 5% of the XC3S500E device. It is hoped that the design may be of interest to anyone interested in PWM and will help you to realise that PicoBlaze is small enough to include in a design even if dedicated to a task such as PWM.

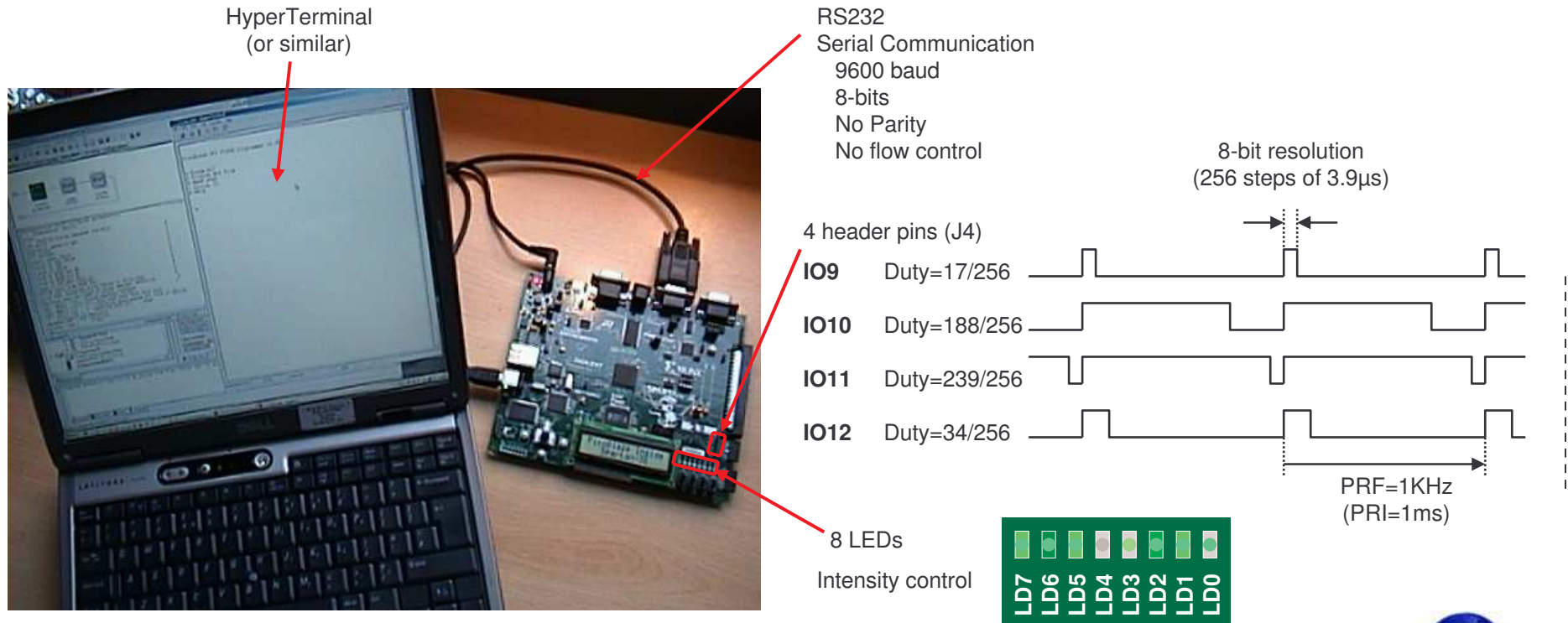

Using the Design

The design is provided as a configuration BIT file for immediate programming of the Spartan XC3S500E provided on the Spartan-3E Starter Kit. Source design files are also provided for those more interested in the intricacies of the design itself. There is also an alternative PicoBlaze program provided along with its compiled XSVF file to demonstrate how PicoBlaze programs can be modified in circuit and further demonstrate PWM control of LED intensity.

USB cable plus some devices on board essentially provide the same functionality as a Platform Cable USB and is used in conjunction with iMPACT.

Initially used to configure the Spartan-3E with the PicoBlaze based design (BIT file).

Can subsequently be used to update the PicoBlaze program stored in an internal Block Memory (BRAM) allowing rapid software changes and experiments.

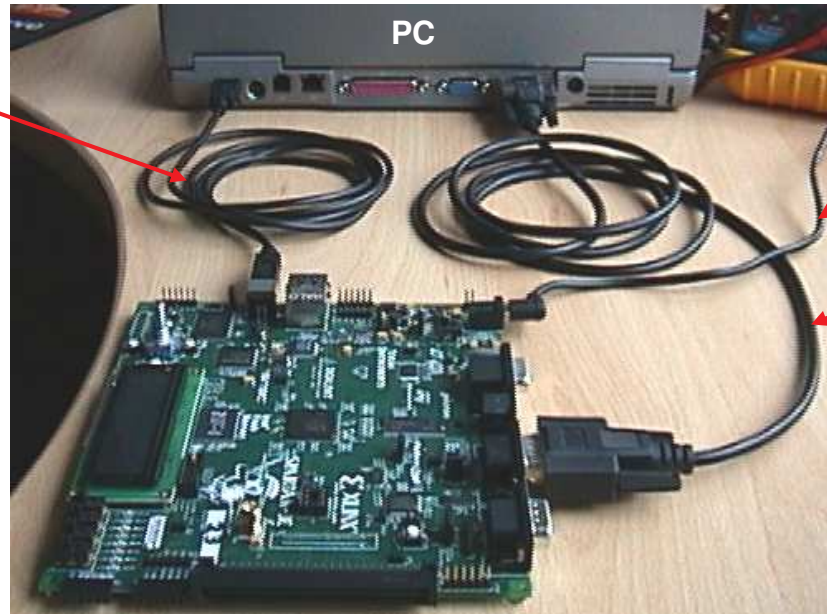

+5v supply
Don't forget to switch the board on too!
(SWP)

RS232 Serial Cable.
Used for setting PWM duty factors
for each channel.

Cable connects J9 on the board to
your PC serial port. For this you will
need a male to female straight
through cable (critically pin2-pin2,
pin3-pin3 and pin5-pin5).

Quick Start - Configure the Spartan-3E with the design

To make this task really easy the first time, unzip all the files provided into a directory and then....

double click on 'install_picoblaze_pwm_control.bat'.

Assuming you have the Xilinx software installed, your board connected with the USB cable and the board powered (don't forget the power switch), then this should open a DOS window and run iMPACT in batch mode to configure the Spartan-3E with the design (configuration BIT file). You should see the LEDs turn on and a message appear on your PC terminal window.

Quick Change – Changing the PicoBlaze program

Make sure you have the base design configured into the Spartan-3E device (see left) and then....

double click on 'update_picoblaze_auto_pwm.bat'.

This should open a DOS window and run iMPACT in batch mode to 'play' the XSVF file containing a new PicoBlaze program such that it is downloaded into a BRAM inside the Spartan-3E device via the user port of the JTAG block (this is the JTAG_loader utility provided with PicoBlaze in action). This program will automatically execute and drive the LEDs in a pattern using PWM. Notice how the intensity of each LED grows and fades rather than simple on/off.

Serial Terminal Setup

An RS232 serial link is used to communicate with the design. Any simple terminal program can be used, but HyperTerminal is adequate for the task and available on most PCs.

A new HyperTerminal session can be started and configured as shown in the following steps. These also indicate the communication settings and protocol required by an alternative terminal utility.

- 1) Begin a new session with a suitable name.
HyperTerminal can typically be located on your PC at
Programs -> Accessories -> Communications -> HyperTerminal.

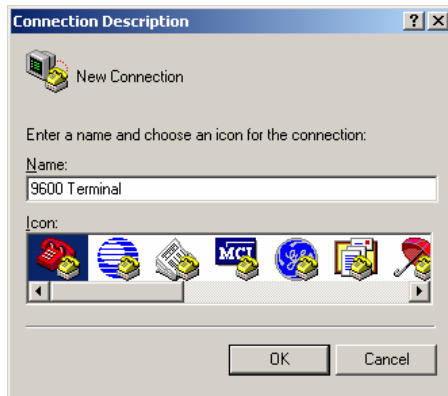

- 2) Select the appropriate COM port (typically COM1 or COM2) from the list of options. Don't worry if you are not sure exactly which one is correct for your PC because you can change it later.

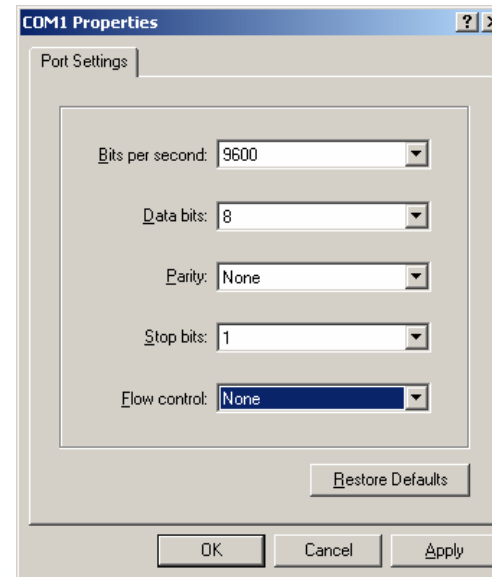

- 3) Set serial port settings.

Bits per second : 9600
Data bits: 8
Parity: None
Stop bits: 1
Flow control: None

Go to next page to complete set up...



HyperTerminal Setup

Although steps 1, 2 and 3 will actually create a Hyper terminal session, there are few other protocol settings which need to be set or verified for the PicoBlaze design to work as expected.

4 - Disconnect

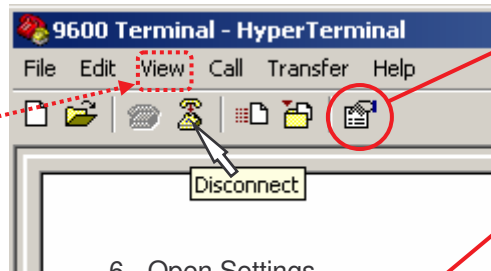

Optional step.....
Set Font to Courier New, Regular, 10

5 - Open the properties dialogue

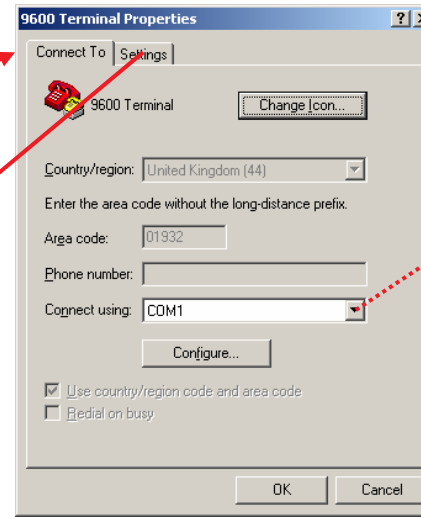

To select a different COM port and change settings (if not correct).

6 - Open Settings

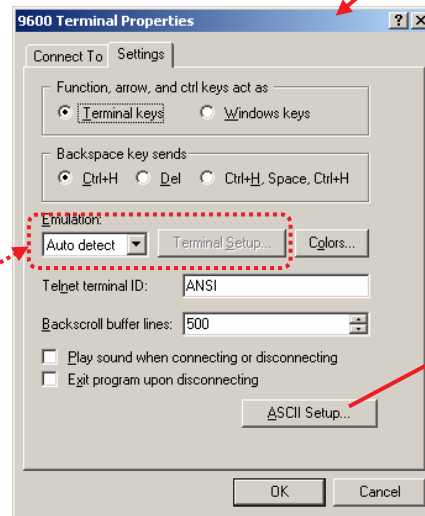

Optional steps.....
Select VT100 and then click 'Terminal Setup'
Set 'Rows' to 40.
(May require you to stretch main screen later to fit).

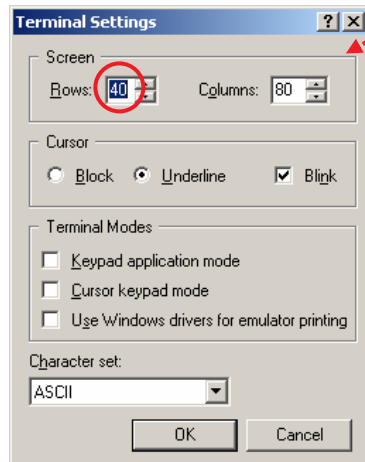

7 - Open ASCII Setup

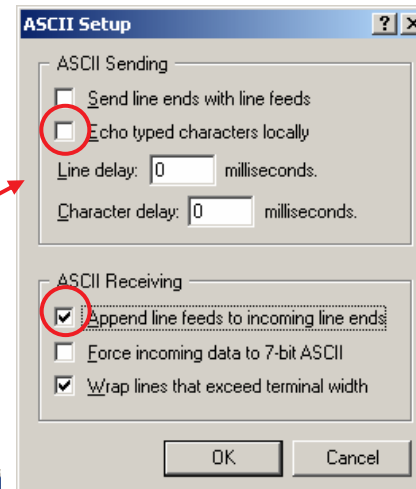

Ensure boxes are filled in as shown.

The design will echo characters that you type so you do not need the 'Echo typed characters locally' option.

The design transmits carriage return characters (OD_{HEX}) to indicate end of line so you do need the 'Append line feeds to incoming line ends' option to be enabled.

8 - 'OK' the boxes to get back to main screen and then Connect.

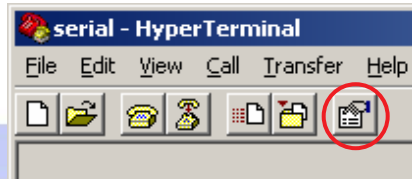

PWM Control

```
9600 - HyperTerminal
File Edit View Call Transfer Help
PicoBlaze PWM Control
KCPSM3>IO9 01
OK
KCPSM3>io10 ff
OK
KCPSM3>ld0 4D
OK
KCPSM3>led2 13
Error
KCPSM3>_
```

← Welcome message

← Enter commands in upper or lower case

← Valid commands acknowledged with 'OK'

← Any mistakes in command entry results in 'Error'

Type commands to the prompt.
Backspace key is supported to allow simple editing.
Single space between command and hex value.
End command entry with Carriage Return.

Connected 0:46:11 VT100 9600 8-N-1 SCROLL CAPS NUM Capture Print echo

The duty cycle for each PWM channel can be set independently using some simple commands typed at the terminal on your PC. Commands should be formatted exactly as described for this simple program to understand them.

Commands to control LEDs (PWM channels 0 to 7)...

LDn hh

Where

'n' is an LED number in the range 0 to 7.

'hh' is a 2 digit hex value to specify the PWM duty factor (range 00 to FF).

Commands to set simple outputs on connector J4...

IOk hh

Where

'k' is an IO number in the range 9 to 12.

'hh' is a 2 digit hex value to specify the PWM duty factor (range 00 to FF).

Some command examples are shown in this HyperTerminal session.

Note that PicoBlaze is able to perform the interpretation of the commands including the simple line editor function whilst maintaining accurate generation of the 12 PWM channels.

Exercise – Determine the smallest duty cycle value which makes an LED visible in daylight and in the dark. Estimate the duty cycle values required to increase the intensity of an LED in what appears to be a linear fashion to the human eye.

Default PWM Settings

Although practical implementations of PWM generators would tend to initialise to the off state (duty cycle of zero), this design is provided to give a mixture of outputs which you can observe and then modify via the terminal commands. The initial duty cycles are as shown below but can be easily changed in the PicoBlaze program if the design is used in a real application.

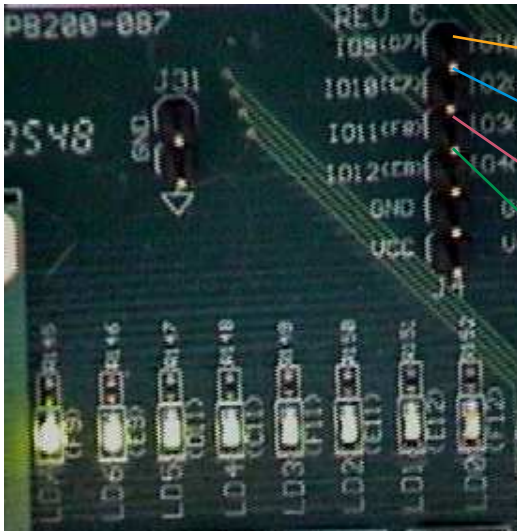

The LEDs should all appear to be on to some degree with the intention that LD0 should appear to be very dim and LD7 very bright. This demonstrates how PWM can be used to control the intensity of an LED and also indicates how PWM can be used in general to achieve intermediate drive strengths by an averaging process of fully 'on' or 'off' states.

Exercise – Connect a simple R-C circuit to IO9 and measure the voltage level realised for different duty cycle settings. Your RC time constant should be large in comparison to the PRF period if you intend to have a smooth output level ($R \times C \gg 1\text{ms}$). Think in terms of a smoothing capacitor after a rectifier and consider how a load will also have an effect on ripple.

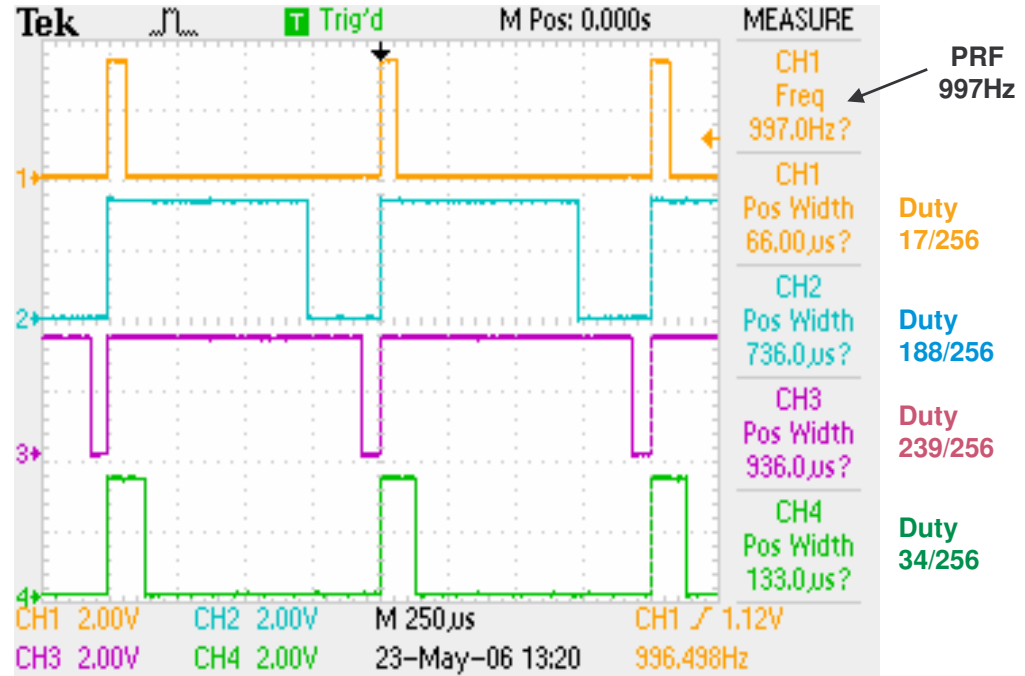

This oscilloscope plot shows the default output from the 4 simple IO pins on connector J4. It shows that the PRF is approximately 1KHz (see page 13) and four different duty cycle settings.

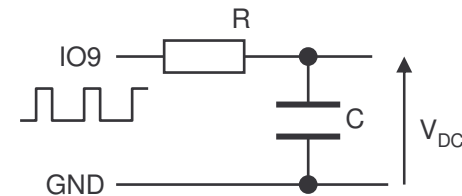

PicoBlaze Design Size

The images and statistics on this page show that the design occupies just 165 slices and 1 BRAM. This is only 3.5% of the slices and 5% of the BRAMs available in an XC3S500E device and would still be less than 18% of the slices in the smallest XC3S100E device.

MAP report

Number of occupied Slices:	165 out of	4,656	3%
Number of Block RAMs:	1 out of	20	5%
Total equivalent gate count for design: 78,962			

PicoBlaze and the UART macros make extensive use of the distributed memory features of the Spartan-3E device leading to very high design efficiency. If this design was replicated to fill the XC3S500E device, it would represent the equivalent of over 1.5 million gates. Not bad for a device even marketing claims to be 500 thousand gates ☺

FPGA Editor view

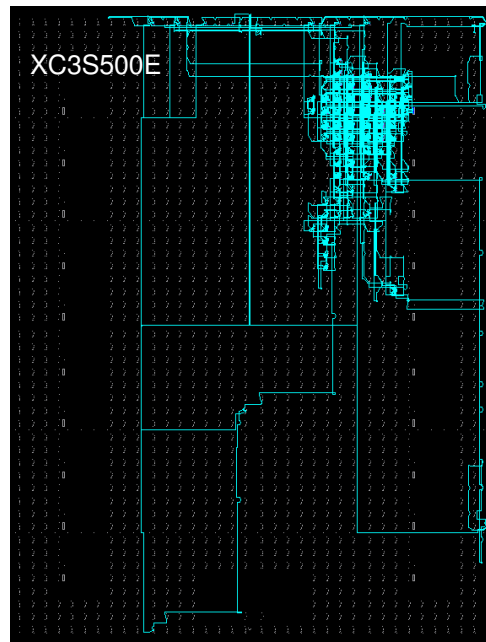

Floorplanner view

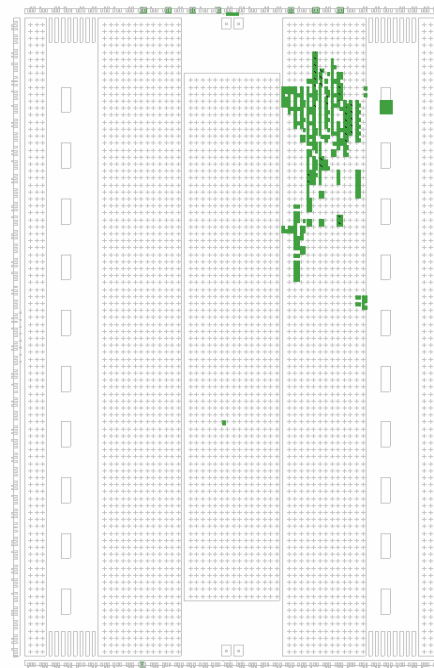

Design Files

The source files provided for the reference design are.....

Hint – Source files contain many comments and descriptions to help you understand the design further.

picoblaze_pwm_control.vhd Top level file and main description of hardware.

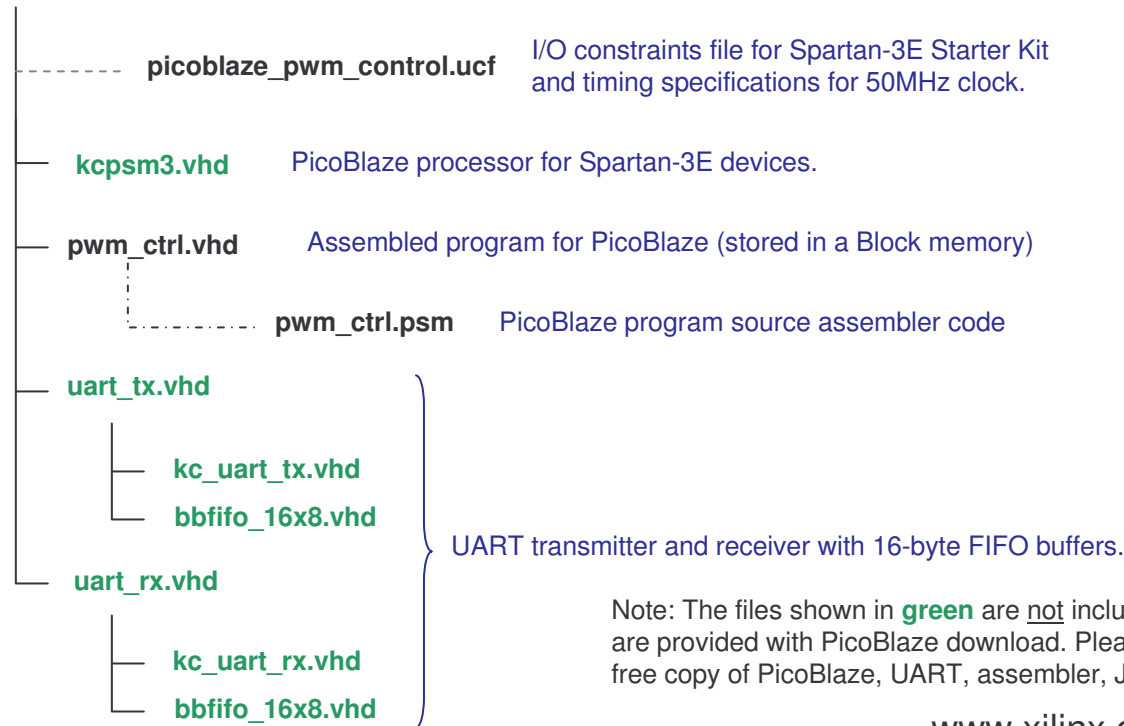

Note: The files shown in **green** are not included with the reference design as they are provided with PicoBlaze download. Please visit the PicoBlaze Web site for your free copy of PicoBlaze, UART, assembler, JTAG_loader and documentation.

www.xilinx.com/picoblaze

auto_pwm.psm } Alternative PicoBlaze program which can be downloaded directly to the PicoBlaze program memory using the
auto_pwm.xsvf } pre-compiled XSVF files provided (See page 4 and JTAG_Loader utility supplied with PicoBlaze).

Hint - If you only want to write new programs for PicoBlaze using the existing hardware design, then use the JTAG_Loader utility supplied with PicoBlaze. The design supplied is already equipped with the JTAG loading circuit (see schematic on next page).



PicoBlaze Circuit Diagram

UART macros include 16-byte FIFO buffers

'JTAG_loader' allows rapid PicoBlaze code development.
(Try downloading the alternative program - see page 4)

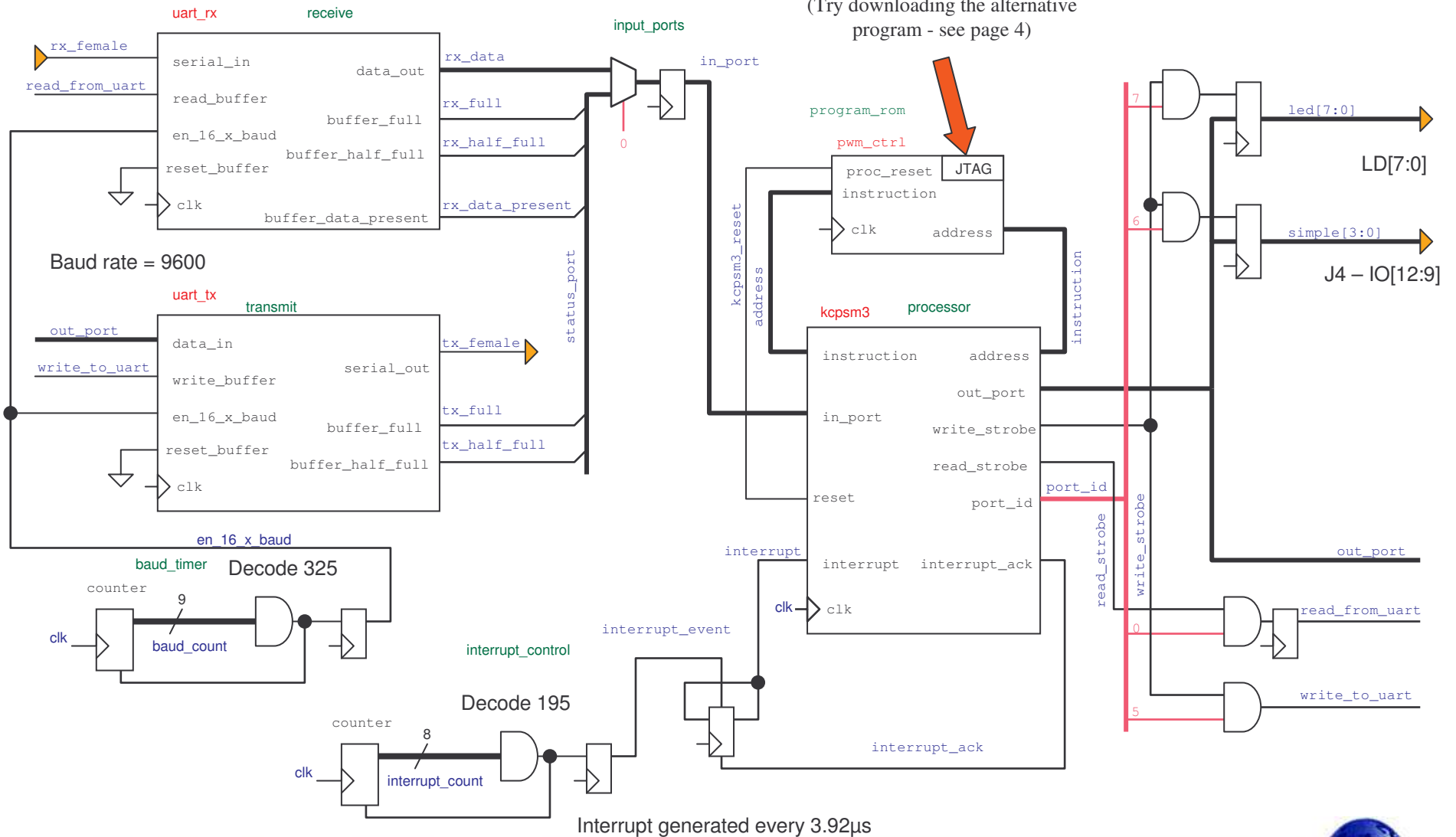

PWM and the Limits of Software

This design deliberately explores the generation of PWM using software executed by PicoBlaze rather than using PicoBlaze in conjunction with PWM hardware peripherals (which will be covered in a subsequent reference design). This means that the dynamics of the PWM are totally flexible by software definition but also means that there are some limits as to what can be achieved.

The two key parameters of PWM are the Pulse Repetition Frequency (PRF) and the resolution (number of steps) by which the duty cycle of each pulse can be set. The design supplied has a PRF of 1KHz and a resolution of 8-bits (256 steps). As such, each step must be resolved at intervals of $3.92\mu\text{s}$.

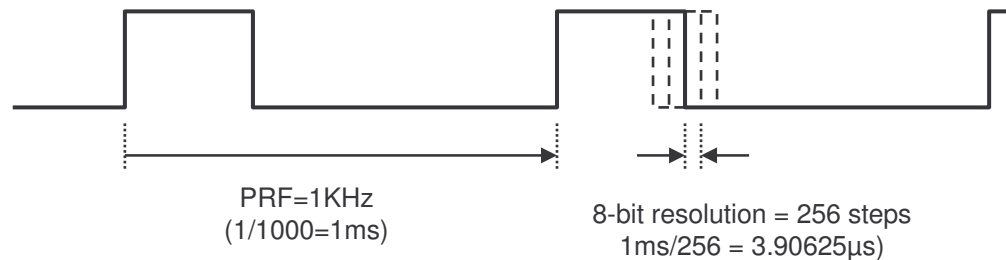

PicoBlaze is a highly predictable processor requiring 2 clock cycles to execute every instruction. Although PicoBlaze can be clocked faster even in the slowest speed grade of Spartan device, this reference makes direct use of the 50MHz oscillator on the board. As such, PicoBlaze is able to execute 25 million instructions per second (MIPS) or one instruction every 40ns. Although this is relatively fast for a small 8-bit microcontroller, it means that it can only execute 97 instructions within the $3.90625\mu\text{s}$ step interval to support the PRF and resolution described above. However, 97 instructions are adequate to drive the PWM signals for all 12 channels and still have ~50% of the processor bandwidth available for the higher level control tasks (dealing with the UART and processing text commands in this case). It should be noted that in this design the PWM generation is continuous. It is quite common for software implementations of PWM with microcontrollers to only support bursts of pulses in order to have time to perform other processing tasks. Such a compromise should never be required when using an FPGA given the high performance of PicoBlaze and the ability to include hardware peripherals if required.

Increasing PRF and/or increasing the duty resolution will reduce the number of instructions which can be executed during each step. In the limit, there will only be enough instructions available to describe the PWM itself and PicoBlaze will have no capacity to actually do anything else. Higher clock rates can be considered, but really this is when a hardware peripheral implemented in the FPGA fabric will make more sense.

Hint – Even if the limits of software execution are reached, it is quite possible to use more than one PicoBlaze processor in any Spartan device. PicoBlaze used in this way can provide ‘intelligent’ PWM peripherals to another PicoBlaze or MicroBlaze processor acting as the main system controller.

Exercise – Determine the maximum PRF which can be achieved for a single channel PWM controller if the resolution is to be 100 steps (8-bit values expressing percent of cycle 0% to 100%). Allow 25% overhead for PicoBlaze to perform higher level tasks using the same 50MHz clock source.

Interrupts Define PWM Timing

Using the fact that all instructions take 2 clock cycles to execute, it is possible to implement PWM 100% in software. However, only by fully dedicating the PicoBlaze to the task of timing generation can the PRF and duty cycles be generated accurately. In most cases, we would want PicoBlaze to provide other functions as well and it would then become almost inevitable that fluctuations in the PRF and duty cycle would result as the various tasks take more or less time to complete. If such variations can be tolerated then such practices can be used and it can be a very efficient use of the processor especially when the PRF and resolution required are relatively low such that the fluctuations appear small.

In this design, the objective has been to provide an accurate PRF and duty resolution and also to provide a high degree of consistency. This is achieved by the use of interrupts which set the fundamental timing of the resolution steps and then absolves the software of any timing requirements other than to be fast enough.

The design uses a simple hardware counter to set the timing for the interrupts. The counter has 196 states and generates the interrupt pulses (see page 11 for more details). This actually equates to an interrupt every $3.92\mu\text{s}$ and a subsequent PRF of 996.5Hz . Although this provides a fixed timing, this could be changed by reprogramming the Spartan-3E device with a modified hardware design. This is often easier and always more efficient than creating a programmable counter/timer module which in turn has to be set up by PicoBlaze software. Of course the implementation of a software programmable counter/timer is always possible, but you should always ask if it is necessary when creating designs which are to be efficient, low cost and reliable.

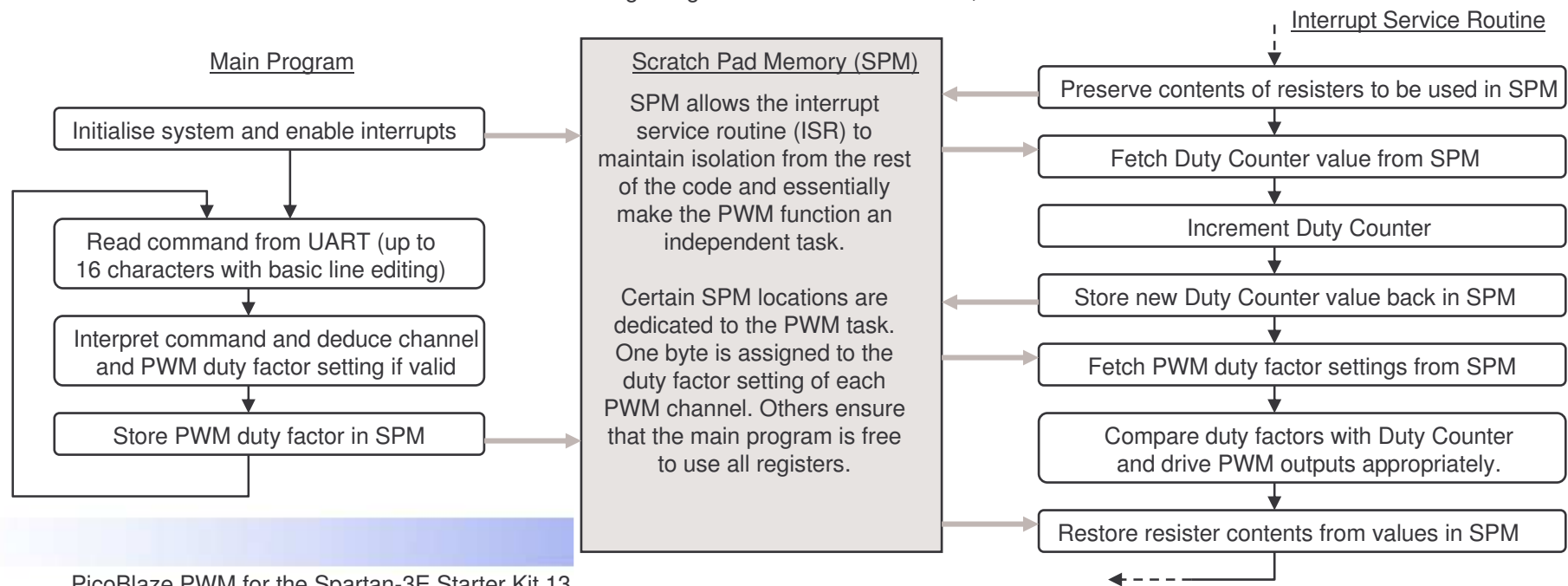
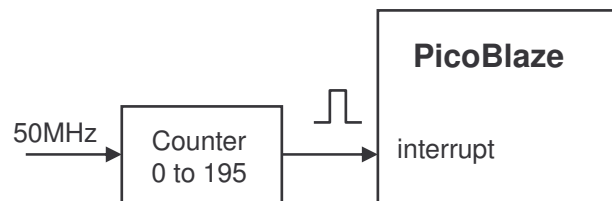

Maximum and Minimum Duty

The implementation provided can turn any channel off completely using a duty cycle value of zero (00 hex). However, the maximum value of 255 (FF hex) actually only represents a duty cycle of 99.6% because the largest value is 255/256.

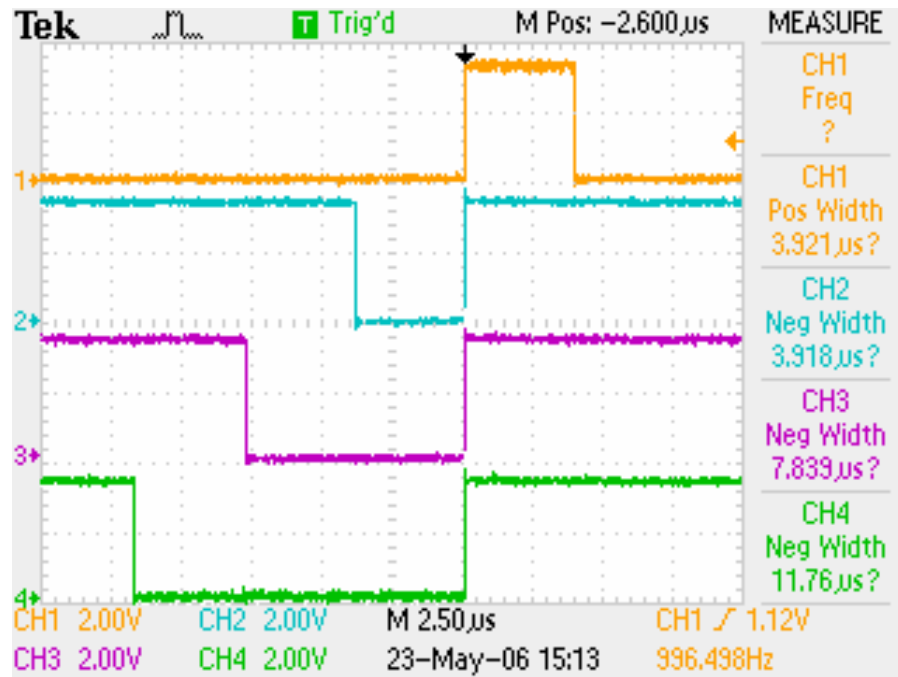

Exercise - Modify the PicoBlaze code to enable both 0% and 100% duty cycle factors to be specified. The design should still use 8-bit values, but the resolution should be reduced to 255 steps such that zero (00 hex) represents fully off and FF hex represents fully on. In your modified design, 01 hex will represent 1/255 rather than 1/256 of the cycle period but the pulse duration will still be 3.92 μs.

Hint – You should find that reducing the steps per cycle to 255 with the existing interrupt hardware will take you closer to a perfect 1KHz PRF.

Hint – Use the JTAG_loader facility with the existing hardware design to verify your code modifications.