

Disclaimer

- Many of these slides are mine
- But, some are stolen from various places on the web
 - todbot.com – Bionic Arduino and Spooky Arduino class notes from Tod E.Kurt
 - ladyada.net – Arduino tutorials by Limor Fried

Getting Input (Digital)

- Switches make or break a connection
- But Arduino wants to see a voltage
 - Specifically, a “HIGH” (5 volts)
 - or a “LOW” (0 volts)

How do you go from make/break to high/low?

Switches

- Digital inputs can “float” between 0 and 5 volts
- Resistor “pulls down” input to ground (0 volts)
- Pressing switch sets input to 5 volts
- Press is HIGH
Release is LOW

“pull-down”

Why do we need the “pull down” resistor?

Another Switch

- Resistor pulls up input to 5 volts
- Switch sets input to 0 volts
- But now the sense is inverted
 - Press is LOW
 - Release is HIGH

“pull-up”

A Switch

Pressing the button, “closes the gap”

Using a Switch

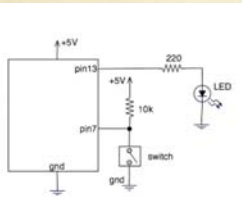

Using digitalRead()

- In `setup()`: use `pinMode(myPin, INPUT)` to make pin an input
- In `loop()`: use `digitalRead(myPin)` to get switch position
 - If doing many tests, use a variable to hold the output value of `digitalRead()`.
 - e.g. `val = digitalRead(myPin)`

digitalRead(pin);

```
// constants won't change. They're used here to set pin numbers:
const int buttonPin = 2; // the number of the pushbutton pin
const int ledPin = 13; // the number of the LED pin

// variables hold values that will change:
int buttonState = 0; // variable for reading the pushbutton status

void setup() {
  pinMode(ledPin, OUTPUT); // initialize the LED pin as an output:
  pinMode(buttonPin, INPUT); // initialize the pushbutton pin as an input:
}

void loop(){
  buttonState = digitalRead(buttonPin); // read the state of the pushbutton
  value:

  if (buttonState == HIGH) { // buttonState HIGH means pressed
    digitalWrite(ledPin, HIGH); // turn LED on:
  } else { digitalWrite(ledPin, LOW); } // turn LED off:
}
}
```

Moving on...

- Write a program that reads the value on an input pin
- Use the button to change from blinking fast to blinking slow

```
int ledPin = 13; // choose the pin for the LED
int inPin = 7; // choose the input pin (for a pushbutton)
int val = 0; // variable for reading the pin status
int delayval = 100;

void setup() {
  pinMode(ledPin, OUTPUT); // declare LED as output
  pinMode(inPin, INPUT); // declare pushbutton as input
}

void loop(){
  val = digitalRead(inPin); // read input value

  if( val == HIGH )
    delayval = 1000;
  else
    delayval = 100;

  digitalWrite(ledPin, HIGH); // blink the LED and go OFF
  delay(delayval);
  digitalWrite(ledPin, LOW);
  delay(delayval);
}
}
```

Multiple Switches

Same sub-circuit,
just duplicate

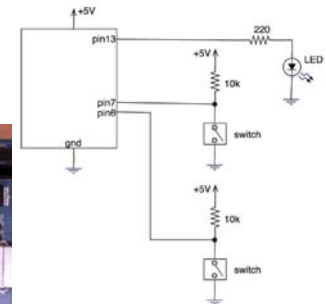
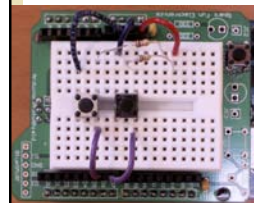

Make Your Own Switches

- Anything that makes a connection
- Wires, tin foil, tinfoil balls, ball bearings
- Pennies!
- Nails, bolts, screws

- Or repurpose these tiny switches as bump detectors or closure detectors

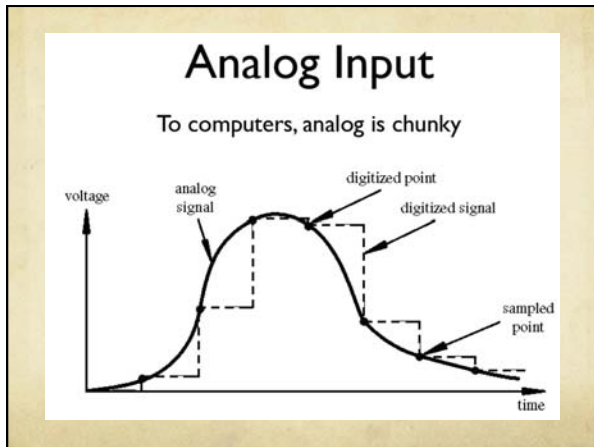
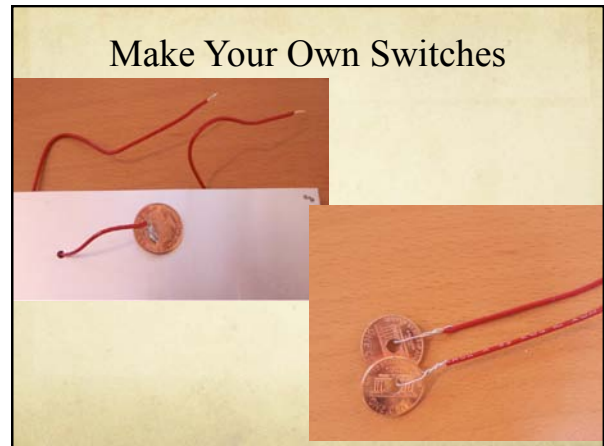

Analog Input

- Many states, not just two (HIGH/LOW)
- Number of states (or "bins") is resolution
- Common computer resolutions:
 - 8-bit = 256 states
 - 16-bit = 65,536 states
 - 32-bit = 4,294,967,296 states

Analog Input on Arduino

- Our version uses ATmega328p
 - six ADC inputs (Analog to Digital Converter)
 - Voltage range is 0-5v
 - Resolution is 10 bits (digital values between 0-1023)
 - In other words, 5/1024 = 4.8mV is the smallest voltage change you can measure
- analogRead(pin);
 - reads an analog pin
 - returns a digital value between 0-1023
 - analog pins need no pinMode declaration

Analog Input

Sure sure, but how to make a varying voltage?
With a *potentiometer*. Or just *pot.*

Potentiometers

Moving the knob is like moving where the arrow taps the voltage on the resistor

turned anti-clockwise

0 volts

turned clockwise

5 volts

somewhere in the middle

2.3 volts

Arduino Analog Input

Red to Vcc
Purple to A0
Blue to Gnd

```
int sensorPin = 0; // select the input pin for the potentiometer
int ledPin = 13; // select the pin for the LED
int sensorValue = 0; // variable to store the value coming from the sensor

void setup() {
  pinMode(ledPin, OUTPUT); // declare the ledPin as an OUTPUT:
  // Note that you don't need to declare the Analog pin – it's always input
}

void loop() {
  sensorValue = analogRead(sensorPin); // read the value from the sensor:
  digitalWrite(ledPin, HIGH); // turn the ledPin on
  delay(sensorValue); // stop the program for <sensorValue> milliseconds:
  digitalWrite(ledPin, LOW); // turn the ledPin off:
  delay(sensorValue); // stop the program for for <sensorValue> milliseconds:
}
```

Moving on...

- Write a program to read an analog value from a pot and use that value to control the brightness of an LED
 - Fade the LED by turning the pot
- Useful function is `map(value, fromlow, fromhigh, tolow, tohigh);`

`y = map(x, 0, 1023, 50, 150);`
- Also remember `analogWrite(pin,value);`
 - PWM value from 0-255

potFade

```
int potPin = 0; // the analog input pin from the pot
int ledPin = 9; // pin for LED (a PWM pin)
int val; // Variable to hold pot value

void setup() {
  pinMode(ledPin, OUTPUT); // declare ledPin as output
  pinMode(potPin, INPUT); // potPin is in input
}

void loop() {
  val = analogRead(potPin); //read the value from the pot
  val = map(val, 0, 1023, 100, 255); // map to reasonable values
  analogWrite(ledPin, val);
}
```

What good are pots?

- Anytime you need a ranged input
 - (we're used to knobs)
- Measure rotational position
 - steering wheel, etc.
- But more importantly for us, potentiometers are a good example of a *resistive sensor*

Sensing the Dark

- Pots are example of a *voltage divider*
- Voltage divider splits a voltage in two
- Same as two resistors, but you can vary them

Sensing the Dark: Photocells

- aka. photoresistor, light-dependent resistor
- A *variable* resistor
- Brighter light == lower resistance
- Photocells you have range approx. 0-10k

schematic symbol

Photocell Circuit

Photocell Arduino Sketch

Can use as before, sketch "analog_read_led"

Change to 0 →

```

int potPin = 2; // select the input pin for the potentiometer
int ledPin = 13; // select the pin for the LED
int val = 0; // variable to store the value coming from the sensor

void setup() {
  pinMode(ledPin, OUTPUT); // declare the ledPin as an OUTPUT
}

void loop() {
  val = analogRead(potPin); // read the value from the sensor
  digitalWrite(ledPin, HIGH); // turn the ledPin on
  delay(val); // stop the program for some time
  digitalWrite(ledPin, LOW); // turn the ledPin off
  delay(val); // stop the program for some time
}
    
```

Wave your hand over it = blink faster
Point it towards the light = blink slower

Moving on...

- Connect a photocell instead of a pot to your fading circuit
- Do you get the same range of fade as with the pot?
- Why or why not?

Resistive sensors

circuit is the same for all these

also air pressure and others

LED Brightness Functions

Then turn those numbers into an array

```
// the table containing the "curve" the brightness should take
byte bright_table[] = { 30, 30, 30, 40, 50, 60, 70, 80, 90,100,
                       110,120,130,140,150,160,170,180,190,200,
                       210,220,230,240,250,250,240,230,220,210,
                       200,190,180,170,160,150,140,130,120,110,
                       100, 90, 80, 70, 60, 50, 40, 30, 30, 30 };
int max_count = 50; // number of entries in the bright_table
```

Use any pattern of numbers you like
but they must range between 0-255

```
0 = full off
127 = half on
255 = full on
```

LED Brightness Functions

Once you have your table...

```
// the table containing the "curve" the brightness should take
byte bright_table[] = { 30, 30, 30, 40, 50, 60, 70, 80, 90,100,
                       110,120,130,140,150,160,170,180,190,200,
                       210,220,230,240,250,250,240,230,220,210,
                       200,190,180,170,160,150,140,130,120,110,
                       100, 90, 80, 70, 60, 50, 40, 30, 30, 30 };
int max_count = 50; // number of entries in the bright_table
```

...the rest is just programming

1. Get a bright_table value
2. Send it out with analogWrite()
3. Advance counter into bright_table
4. Wait a bit
5. Repeat

Glowing Eyes Sketch

```
int potPin = 0;
int ledPin = 10;

// the table containing the "curve" the brightness should take
byte bright_table[] = { 30, 30, 30, 40, 50, 60, 70, 80, 90,100,
                       110,120,130,140,150,160,170,180,190,200,
                       210,220,230,240,250,250,240,230,220,210,
                       200,190,180,170,160,150,140,130,120,110,
                       100, 90, 80, 70, 60, 50, 40, 30, 30, 30 };
int max_count = 50; // number of entries in the bright_table
int count = 0; // position within the bright_table
int val = 0; // variable for reading pin status

void setup() {
  pinMode(ledPin, OUTPUT); // sets the digital pin as output
}

void loop() {
  analogWrite(ledPin, bright_table[count]); // sets the LED bright
  count++; // moves counter to next position in table
  if( count > max_count )
    count = 0; // If at end of table, back to start

  val = analogRead(potPin);
  val = val/4; // scale it down so it's quicker
  delay(val);
}
```



Communicating with Others

- Arduino can use same USB cable for programming and to talk with computers
- Talking to other devices uses the "Serial" commands
 - Serial.begin() – prepare to use serial
 - Serial.print() – send data to computer
 - Serial.read() – read data from computer

Serial from Arduino to PC

- Serial.begin(baud-rate);
 - baud-rate is 300, 1200, 2400, 4800, 9600, 14400, 19200, 28800, 57600, or 115200
 - Sets serial bit rate
- Serial.print(arg);
 - sends arg to the serial output – can be number or string
 - Serial.print(arg,format); // formats the arg
 - format can be BYTE, BIN, OCT, DEC, HEX
- Serial.println(arg);
 - Same, but also prints a newline to the output

Send data to PC

```
void setup() {
  Serial.begin(9600); // init the serial port
}

void loop() {
  Serial.println("Hello World!"); // print to the screen!
  delay(500); // Wait so you don't print too fast
}
```

Checking on Analog Inputs

```
int sensorPin = 0; // select the input pin for the potentiometer
int ledPin = 13; // select the pin for the LED
int sensorValue = 0; // variable to store the value coming from the sensor

void setup() {
  pinMode(ledPin, OUTPUT); // declare the ledPin as an OUTPUT.
  Serial.begin(9600); // Init serial communication at 9600 baud
}

void loop() {
  sensorValue = analogRead(sensorPin); // read the value from the sensor.
  Serial.print("Sensor value is: "); // print a message
  Serial.println(sensorValue, DEC); // print the value you got
  delay(500); // wait so you don't print too much!
}
// VERY useful for getting a feel for the range of values coming in
// map(value, inLow, inHigh, outLow, outHigh);
```

Serial From PC to Arduino

- Serial.available();
 - returns an int that tells you how many bytes remain in the input buffer
- Serial.read();
 - returns the next byte waiting in the input buffer
- Serial.flush();
 - clear the input buffer of any remaining bytes

Serial Read Example

```
int incomingByte = 0; // for incoming serial data
void setup() {
  Serial.begin(9600); // opens serial port, sets data rate to 9600 bps
}

void loop() { // send data only when you receive data:
  if (Serial.available() > 0) { // read the incoming byte:
    incomingByte = Serial.read();

    // say what you got:
    Serial.print("I received: ");
    Serial.println(incomingByte, DEC);
  }
}
```

Arduino Says "Hi"

"SerialHelloWorld"

Sends "Hello world!" to your computer

Click on "Serial Monitor" button to see output

Watch TX LED compared to pin 13 LED



Telling Arduino What To Do

"SerialReadBasic"

You type "H", LED blinks

In "Serial Monitor", type "H", press Send

Serial.available() tells you if data present to read



Arduino Communications

is just serial communications

- Psst, Arduino doesn't really do USB
- It really is "serial", like old RS-232 serial
- All microcontrollers can do serial
- Not many can do USB
- Serial is easy, USB is hard



serial terminal from the olde days

Serial Communications

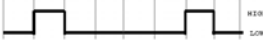
- "Serial" because data is broken down into bits, each sent one after the other down a single wire.
- The single ASCII character 'B' is sent as:
 - 'B' = 0 1 0 0 0 0 1 0
 - = L H L L L L H L
 - = 
- Toggle a pin to send data, just like blinking an LED
- You could implement sending serial data with `digitalWrite()` and `delay()`
- A single data wire needed to send data. One other to receive.

Arduino & USB-to-serial

Arduino board is really two circuits

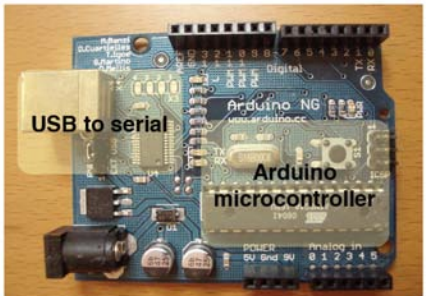

Arduino Mini

Arduino Mini separates the two circuits

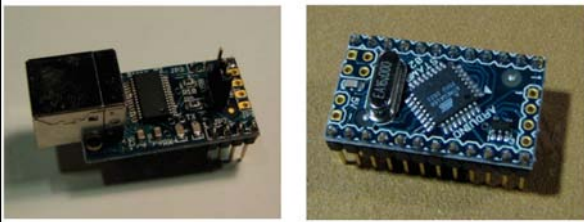

Arduino Mini USB adapter Arduino Mini

Arduino to Computer

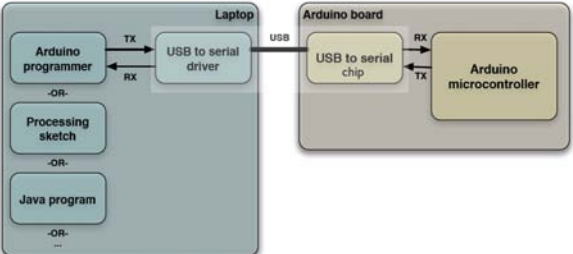

USB is totally optional for Arduino
But it makes things easier

Arduino & USB

- Since Arduino is all about serial
- And not USB,
- Interfacing to things like USB flash drives, USB hard disks, USB webcams, etc. is *not* possible

Controlling the Computer

- Can send sensor data from Arduino to computer with `Serial.print()`
- There are many different variations to suite your needs:

```
int val = 123;
Serial.print(val); // sends 3 ASCII chars "123"
Serial.print(val,DEC); // same as above
Serial.print(val,HEX); // sends 2 ASCII chars "7B"
Serial.print(val,BIN); // sends 8 ASCII chars "01111011"
Serial.print(val,BYTE); // sends 1 byte, the verbatim value
```

Controlling the Computer

You write one program on Arduino, one on the computer

In Arduino: read sensor, send data as byte

```
void loop() {
  val = analogRead(analogInput); // read the value on analog input
  Serial.println(val, BYTE); // print a byte value out
  delay(50); // wait a bit to not overload the port
}
```

In Processing: read the byte, do something with it

```
import processing.serial.*;

Serial myPort; // The serial port

void setup() {
  String portName = "/dev/tty.usbserial-A3000000";
  myPort = new Serial(this, myPort, 9600);
}

void draw() {
  while (myPort.available() > 0) {
    int inByte = myPort.read();
    println(inByte);
  }
}
```

Controlling the Computer

- Receiving program on the computer can be in any language that knows about serial ports
- C/C++, Perl, PHP, Java, Max/MSP, Python, Visual Basic, etc.
- Pick your favorite one, write some code for Arduino to control

Controlling Arduino, Again

"SerialReadBlink"

Type a number 1-9 and LED blinks that many times

Converts typed ASCII value into usable number

Most control issues are data conversion issues

```
void loop() {
  val = Serial.read(); // read the serial port
  // If the stored value is a single-digit number, blink the LED the
  if (val > '0' && val <= '9') {
    val = val - '0'; // convert from character to number
    for(int i=0; i<val; i++){
      Serial.println("blink!");
      digitalWrite(LED_PIN, HIGH);
      delay(150);
      digitalWrite(LED_PIN, LOW);
      delay(150);
    }
  }
}
```

Dec	Hex	Char	Code	Dec	Hex	Char	Dec	Hex	Char
0	00		NUL	32	20	!	64	40	@
1	01		SOH	33	21	!	65	41	A
2	02		STX	34	22	"	66	42	B
3	03		ETX	35	23	#"	67	43	C
4	04		EOT	36	24	#\$	68	44	D
5	05		ENQ	37	25	%	69	45	E
6	06		ACK	38	26	&	70	46	F
7	07		BEL	39	27	'	71	47	G
8	08		BS	40	28	(72	48	H
9	09		HT	41	29)	73	49	I
10	0A		LF	42	2A	*	74	4A	J
11	0B		VT	43	2B	+	75	4B	K
12	0C		FF	44	2C	,	76	4C	L
13	0D		CR	45	2D	-	77	4D	M
14	0E		SO	46	2E	.	78	4E	N
15	0F		SI	47	2F	/	79	4F	O
16	10		DLE	48	30	0	80	50	P
17	11		DC1	49	31	1	81	51	Q
18	12		DC2	50	32	2	82	52	R
19	13		DC3	51	33	3	83	53	S
20	14		DC4	52	34	4	84	54	T
21	15		NAK	53	35	5	85	55	U
22	16		SYN	54	36	6	86	56	V
23	17		ETB	55	37	7	87	57	W
24	18		CAN	56	38	8	88	58	X
25	19		EM	57	39	9	89	59	Y
26	1A		SUB	58	3A	:	90	5A	Z
27	1B		ESC	59	3B	;	91	5B	[
28	1C		FS	60	3C	<	92	5C	\
29	1D		GS	61	3D	=	93	5D]
30	1E		RS	62	3E	>	94	5E	^
31	1F		US	63	3F	?	95	5F	_

ASCII code 127 has the code DEL. Under MS-DOS, this code has the same effect as ASCII 8 (BS). The DEL code can be generated by the CTRL + BSFP key.

Standard byte codes for characters

Mysterious `val = val - '0'`; statement converts the byte that represents the character to a byte of that number

For example, if the character is '3', the ASCII code is 51

The ASCII code for '0' is 48

So, 51 - 48 = 3

This converts the character '3' into the number 3

Reading Serial Strings

- The function "Serial.available()" makes reading strings easier
- Can use it to read all available serial data from computer
- The "readSerialString()" function at right takes a character string and sticks available serial data into it

```
//read a string from the serial and store it in an array
//you must supply the array variable
void readSerialString (char *strArray) {
  int i = 0;
  if (Serial.available()) {
    return;
  }
  while (Serial.available()) {
    strArray[i] = Serial.read();
    i++;
  }
  strArray[i] = 0; // indicate end of read string
}
```

Moving on... Servos

- Servo motors are small DC motors that have a range of motion of 0-180°
- Internal feedback and gearing to make it work
- easy three-wire interface
- position is controlled by PWM signals

PWM

Output voltage is averaged from on vs. off time

$output_voltage = (on_time / off_time) * max_voltage$

PWM

- Used everywhere
 - Lamp dimmers, motor speed control, power supplies, noise making
- Three characteristics of PWM signals
 - Pulse width range (min/max)
 - Pulse period (= 1/pulses per second)
 - Voltage levels (0-5V, for instance)

Servomotors

- Can be positioned from 0-180° (usually)
- Internal feedback circuitry & gearing takes care of the hard stuff
- Easy three-wire PWM 5V interface

Servos are Awesome

- DC motor
- High-torque gearing
- Potentiometer to read position
- Feedback circuitry to read pot and control motor
- All built in, you just feed it a PWM signal

Servos, good for what?

- Roboticians, movie effects people, and puppeteers use them extensively
- Any time you need controlled, repeatable motion
- Can turn rotation into linear movement with clever mechanical levers

Servos

- Come in all sizes
 - from super-tiny 9g
 - to drive-your-car
- But all have the same 3-wire interface
- Servos are spec'd by:
 - weight: 9g
 - speed: .12s/60deg @ 6V
 - torque: 22oz/1.5kg @ 6V
 - voltage: 4.6-6V
 - size: 21x11x28 mm

Our servos are: weight: 9g, speed 0.12s/60deg at 4.8v, torque (@4.8v) 17.5oz/in (1kg/cm) voltage range: 3.0 - 7.2v

Servo Mounts & Linkages

Lots of ways to mount a servo



And turn its rotational motion into other types of motion

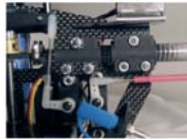

Servo Control

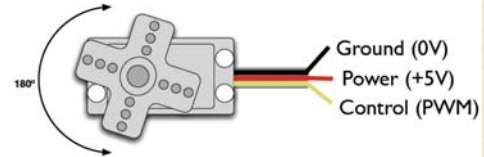

- PWM freq is 50 Hz (i.e. every 20 milliseconds)
- Pulse width ranges from 1 to 2 milliseconds
 - 1 millisc = full anti-clockwise position
 - 2 millisc = full clockwise position

Servo Movement

0 degrees



1000 microseconds

90 degrees



1500 microseconds

180 degrees



2000 microseconds

In practice, pulse range can range from 500 to 2500 microseconds

Servo and Arduino

First, add some jumper wires to the servo connector

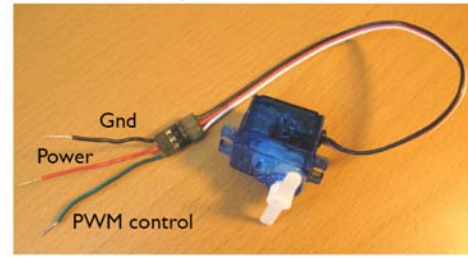

Servo Example Program

```
#include <Servo.h> // include the built-in servo library
Servo myservo; // create a servo object to control the servo (one per servo)
int pos = 0; // variable to store the servo position

void setup() {
  myservo.attach(9); // attach servo control to pin 9
}

void loop() {
  for (pos = 0; pos < 180; pos++) { // go from 0 to 180 degrees
    myservo.write(pos); // move the servo
    delay(15); // give it time to get there
  }
  for (pos = 180; pos >= 1; pos--) { // wave backwards
    myservo.write(pos);
    delay(15);
  }
}
```

Servo Functions

- Servo is a class
 - `Servo myservo;` // creates an instance of that class
- `myservo.attach(pin);`
 - attach to an output pin (doesn't need to be PWM pin!)
 - Servo library can control up to 12 servos on our boards
 - but a side effect is that it disables the PWM on pins 9 and 10
- `myservo.write(pos);`
 - moves servo – pos ranges from 0-180
- `myservo.read();`
 - returns the current position of the servo (0-180)

Moving on...

- Write a program to control the position of the servo from a pot, or from a photocell
 - remember pot `analogRead()`; values are from 0-1023
 - measure the range of values coming out of the photocell first?
 - use `Serial.print(val)`; for example
 - use `map(val, in1, in2, 0, 180)`; to map in1-in2 values to 0-180
 - Can also use `constrain(val, 0, 180)`;

Side Note - Power

- Servos can consume a bit of power
 - We need to make sure that we don't draw so much power out of the Arduino that it fizzes
 - If you drive more than a couple servos, you probably should put the servo power pins on a separate power supply from the Arduino
 - Use a wall-wart 5v DC supply, for example

Robo Cat Toy Idea

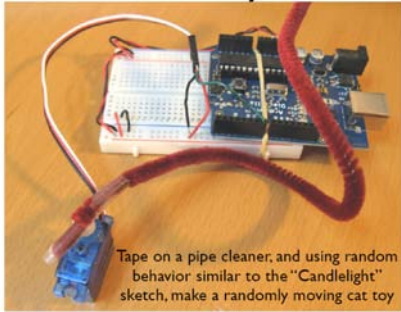

Servo/Light Assignment

- Use a photocell on the input
 - put in series with 10k ohm resistor
- use a servo on the output
 - connect to a PWM pin
- make the servo do something in response to the amount of light falling on the photocell

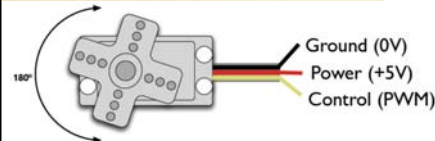
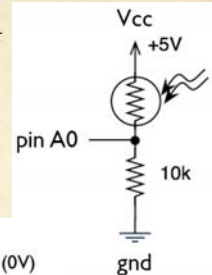

Summary – Whew!

- LEDs – use current limiting resistors (remember color code!)
 - drive from `digitalWrite(pin,val)`; for on/off
 - drive from `analogWrite(pin,val)`; for PWM dimming (values from 0-255)
- buttons – current limiting resistors again
 - active-high or active low (pullup or pulldown)
 - read with `digitalRead(pin)`;
- potentiometers (pots)– voltage dividers with a knob
 - use with `analogRead(pin)`; for values from 0-1023

Summary – Whew!

- photocells – variable resistors
 - use with current-limiting resistors (to make voltage divider)
- Serial communications – read a byte, or write a value
 - communicate to the Arduino environment, or your own program
- Servos – use Servo library to control motion
 - might need external power supply
 - range of motion 0-180°
- Also `setup()` and `loop()` functions, and various C programming ideas

More Later...

- DC Motors
 - use transistors as switches for larger current loads
- Stepper motors
 - Sort of like servos, but with continuous range of motion
 - Can also be more powerful
- I2C serial bus
 - Various LED driver chips
 - other serially-controlled devices
- Piezo buzzers
 - make some noise!
 - But you can also use them as input devices to sense movement
- IR motion sensors
 - simple motion and also distance sensors
- Accelerometers
 - Wii nunchucks, for example
- Others?